

**Automation for residential sliding gates
up to 900 Kg**

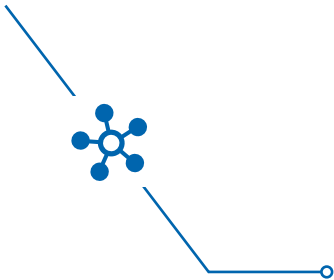

Control board positioned in a lifted position at the front. Always accesible and perfect for small or narrow spaces



Battery kit with dedicated support (optional and only for 24V models)

Dedicated support for bluetooth device NET-NODE



Models available with **magnetic limit switches**

Invisible fixing system, with threaded rod

Compatible with **external unlocking device by cable** (art. 450N to be used with BLINDOS - optional)

NETLINK OPERATOR

This operator is compatible with the NETLINK System and can be programmed with DEAINSTALLER and NETBOX

(Only versions with NET24N, NET230N, or NET724N)





Compatible with the Apps



KIT

230V ~ operators with control board, limit switches and encoder



COD.	Art.						OTHER CHARACTERISTICS
614700	LIVI 6N		600 kg		NET230N	✓	<ul style="list-style-type: none"> • Irreversible with limit switches (magnetic only for 6N/M and 9N/M versions) • Speed adjustment and slow down in opening and closing • Motor control by encoder and obstacle detection • Anti-crushing safety device
614701	LIVI 6N/M		600 kg		NET230N	✓	
615700	LIVI 9N		900 kg		NET230N	✓	
615701	LIVI 9N/M		900 kg		NET230N	✓	

All models have: control board and fixing plate (to be screwed) included

24V = operators with control board and limit switches



COD.	Art.					OTHER CHARACTERISTICS
614750	LIVI 6/24N/F		600 kg		NET24N	<ul style="list-style-type: none"> • Irreversible with limit switches (magnetic only for 6/24N/M, 6/24N/M-BOOST and 9/24N/M versions) • Speed adjustment and slow down in opening and closing • Anti-crushing safety device • Versions with increased speed only in BOOST models (16m/min)
614752	LIVI 6/24N/M		600 kg		NET24N	
614751	LIVI 6/24N/F-BOOST		600 kg		NET24N	
614753	LIVI 6/24N/M-BOOST		600 kg		NET24N	
615750	LIVI 9/24N/F		900 kg		NET24N	
615751	LIVI 9/24N/M		900 kg		NET24N	

All models have: control board and fixing plate (to be screwed) included

212E 230V ~ operators with control board and limit switches



COD.	Art.				OTHER CHARACTERISTICS
614702*	LIVI 403N*	400 kg		212E	<ul style="list-style-type: none"> • ATTENTION: not compatible with NETLINK • Self-locking with limit switches • Electronic force adjustment • Automatic working time learning • Controlled input for external safety device
615702*	LIVI 803N*	800 kg		212E	

All models have: fixing plate (to be screwed) included

* In order to respect the limit of impact forces foreseen by EN 12453, you must use the external safety devices in compliance with EN 12978.

TECHNICAL INFO	LIVI 403N - LIVI 6N LIVI 6N/M	LIVI 803N - LIVI 9N LIVI 9N/M	LIVI 6/24N/F LIVI 6/24N/M	LIVI 6/24N/F-BOOST LIVI 6/24N/M-BOOST	LIVI 9/24N/F LIVI 9/24N/M
Motor power supply (V)	230V ~ ±10% (50/60 Hz)		24V $\overline{=}$		
Maximum power absorption (W)	320	450	80		110
Max thrust (N)	340	490	210	240	260
Duty cycle (cycles/h)*	18	11	22		18
N. max. cycles in 24h*	60	40	60		40
Built-in capacitor (μ F)	8	12,5	\		
Operating temperature ($^{\circ}$ C)	-20 ÷ 50				
Motor thermal protection ($^{\circ}$ C)	140	160	\		
Speed (m/min)	10		16		10
Standard pinion	Z16	Z16	Z16	Z16	Z16
Weight with packing (Kg)	11	12,5	12		
Sound pressure (dBA)	< 70				
Protection level	IPX4 (IP44 for versions with magnetic limit switches)				

* For a 5m leaf length

EXAMPLE OF A TYPICAL INSTALLATION

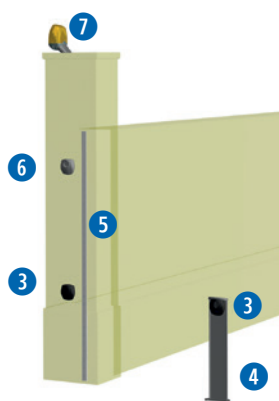
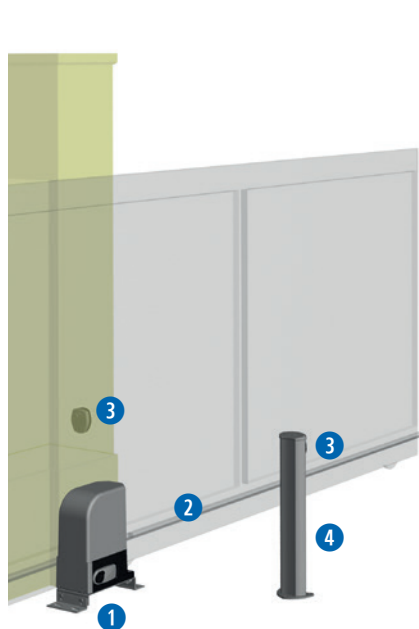

DIMENSIONS

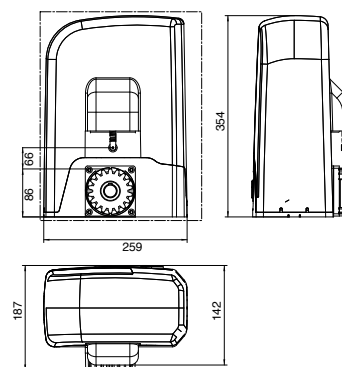

KIT

1

COD. 614700
Art. LIVI 6N
Automation for residential sliding gates

2

COD. 619000
Art. 111
Nylon rack, with fixing screws (1m)

KIT

3

COD. 662080
Art. LINEAR/XS
Pair of mini synchronizable photocell for outdoor installation. Maximum range 20m

4

COD. 664000
Art. PILLY/60
55cm column for photocell (2 pcs)

5

COD. 171035
Art. C-20
Mechanical edge L=2m

6

COD. 663090
Art. GT-KEY
Metal vandal proof keyswitch with two contacts, surface mounted. Supplied with 2 keys.

KIT

7

COD. 661063
Art. AURA230
230V flashing light, LED, with integrated antenna, 433 MHz

KIT

COD. 672645
Art. GT4
Serialized white 4-channel remote control, 433 MHz, with 3 coding: HCS Rolling-Code, Dip-Switch and new D.A.R.T. coding

KIT

for further details on the kits see price list 2019

SPECIFIC ACCESSORIES

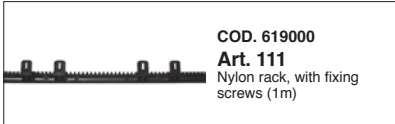

COD. 619000
Art. 111
Nylon rack, with fixing screws (1m)



COD. 126001
Art. 112
Galvanized steel rack 22x22mm (1m)

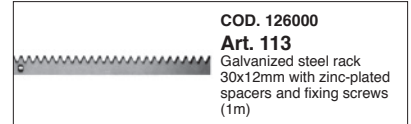

COD. 126000
Art. 113
Galvanized steel rack 30x12mm with zinc-plated spacers and fixing screws (1m)

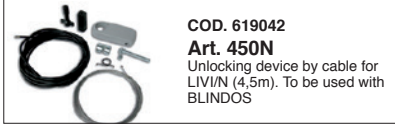

COD. 619042
Art. 450N
Unlocking device by cable for LIVI/N (4,5m). To be used with BLINDOS



COD. 619012
Art. 460N
Additional foundation plate for LIVI/N



COD. 672920
Art. D-BAND KIT
Wireless transmitter and receiver kit in 868 MHz, for resistive or mechanical safety edges

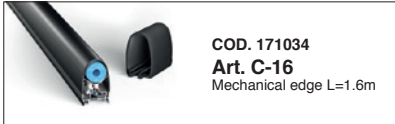

COD. 171034
Art. C-16
Mechanical edge L=1.6m



COD. 171035
Art. C-20
Mechanical edge L=2m



COD. 171039
Art. CR-20
Resistive edge L=2m



COD. 171040
Art. CR-25
Resistive edge L=2,5m

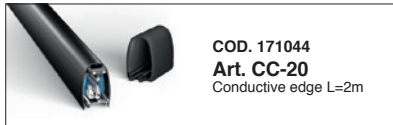

COD. 171044
Art. CC-20
Conductive edge L=2m



COD. 667053
Art. SOFT3
Safety rubber profile (complete with aluminium base) useful to reduce the impact forces for sliding and swing gates (12m)



COD. 629292
Art. BAT/LIVI/N SUPPORT
Fixing plate for LIVI/N batteries with screws



COD. 665000
Art. BLINDOS
Aluminium safety enclosure, with European cylinder, ready for unlocking device by cable.



COD. 629291
Art. BAT/LIVI 3-6-9/24
Rechargeable batteries kit for 24V operators, 12V - 1,2Ah, complete with wiring cables and fixing plate